



HomeStation Level 2 Charger

INSTALLATION AND OPERATION MANUAL

Version: 1.0.7

Issue Date: August 31, 2021



ELECTRIFYHOME.COM

Customer Support: (833) 532-2778

Contents

1 Information	04	4 Operating Instructions	12
1 Copyright	04	5 Charger Status	14
2 About This Document	04	1 Status Indicator	14
3 Intended Use	04	2 Indicator Definition	14
4 Charger–Intended Use	04	3 Understanding Status Indicator Patterns	15
5 Important Safety Instructions	04	4 Faults	15
6 EMC Compliance Statement: FCC Part 15, Subpart B, Class B	05	6 Troubleshooting	16
2 Product Overview	06	7 Specifications	17
1 Included Components List	07	8 Moving, Transportation, and Storage	18
2 Recommended Tools	07	9 Cleaning	18
3 Installation Instructions	08	10 Warranty	18
1 Before Installing	08	11 Disposal	18
2 Installation Steps	09		
3 Installation with Hardwiring	10		

Information

1 Copyright

Copyright © 2021 Electrify America, LLC. All rights reserved. This document is copyright protected. It may not be changed, reproduced, or distributed without prior agreement issued in writing by Electrify America.

2 About This Document

These instructions describe how to operate and care for the charger properly. Additional instructions are provided in the Electrify America app, and we recommend you view the app before using the charger. For your personal safety, follow the operating instructions exactly. **We recommend that a certified electrician perform all in-home installations, and this charger should not be installed in any circumstances without first consulting with an electrician familiar with your home, its electrical panel and wiring. Only qualified, certified electricians should hardwire this charger.**

3 Intended Use

These instructions apply to the charger and its use in the USA. Follow all federal, state, and local laws, regulations, ordinances, codes and safety standards.

4 Charger—Intended Use

1. This device is intended for indoor and outdoor use. Do not obscure the label on the charger. All persons using the charger must first read and understand these instructions.
2. This device is intended exclusively for the charging of electric vehicles fitted with a Type 1 plug (SAE J1772) and charging current control via the pilot signal (IEC 61851-1:2017). Do not use the charger to charge or supply other devices. Follow all federal, state, and local laws, regulations, ordinances, and safety standards regarding use of this device.



5 Important Safety Instructions

READ ALL THE INSTRUCTIONS BEFORE INSTALLING, OPERATING, MAINTAINING, OR USING THIS PRODUCT. SAVE THESE INSTRUCTIONS. THEY MUST BE PROVIDED TO EACH NEW OWNER.



DANGER: RISK OF ELECTRICAL SHOCK.

INSTRUCTIONS PERTAINING TO A RISK OF FIRE OR ELECTRICAL SHOCK.

1. Do not use any adapters, converters, extension cords, or extension cables to increase the length of the charging cable or power supply cord.
2. Do not install this charger on a GFCI circuit breaker.
3. Supervise children when device is in use. Children under 16 should not operate this device. Also, small parts are dangerous for children. Do not install in the presence of children.
4. Do not put fingers into the electric vehicle connector.
5. Do not use this product if the power supply cord or the electric vehicle cable is frayed, has broken insulation, or shows any other signs of damage.
6. Do not use this product if the enclosure or the electric vehicle connector is broken, cracked, open, or shows any other indication of damage.
7. The ambient operating temperature range for this device is -22°F (-30°C) to +122°F (+50°C). Do not operate the charger outside this operating range.
8. Electrify America is not responsible for physical injury or damage to property or equipment caused by the installation, usage, repair, or maintenance of this product.
9. These instructions describe the usage of the charger in most commonly used installation and mounting scenarios. If situations arise in which it is not possible to perform an operation following the procedures provided in this document,



Important Safety Instructions (continued)

contact Electrify America. Electrify America is not responsible for any damages that may occur resulting from custom installations or operations that are not described in this document.

10. Personal protection equipment: Use of proper personal protection equipment (including, but not limited to, eye protection, shock protection, gloves, and other appropriate protection) is recommended when installing or servicing any electrical equipment. To reduce the risk of fire, only connect this equipment to a maximum 50 amperes overcurrent protection device in accordance with the National Electrical Code, ANSI/NFPA.
11. Do not use this equipment in an area with hazardous or flammable materials or vapors. Store hazardous and flammable vapors and materials away from all electrical equipment during installation.
12. Arcing component in contactor: The charger includes contactors that, when opened or closed, will cause a short duration arc. The contactor is enclosed in an appropriate electrical enclosure, but caution is required if this arc occurs in the presence of flammable vapors—as the vapors could ignite, creating an explosion.
13. Do not open the charger at any time during installation or operation! Only trained personnel should open the charger.
14. Handling live components incorrectly may cause serious injuries or death.
15. If the electricity service to the charger is damaged, immediately shut down the power to the charger by switching off the circuit breaker and contact a licensed electrician.
16. Turn off circuit before remounting or replacing the charger.
17. To reduce the risk of fire, connect only to a circuit provided with the proper maximum branch circuit overcurrent protection in accordance with the National Electrical Code and local laws, regulations, codes, and standards.
18. Ensure that all components are dry throughout the installation.
19. Product is subject to modification without prior notice. This document might not contain the latest changes to the product's specifications or processes described

herein. For the most up-to-date information, please visit [electrifyhome.com](https://www.electrifyhome.com).

6 EMC Compliance Statement: FCC Part 15, Subpart B, Class B

FCC ID: 2AX8SEA2R040JPA1000

1. Radiofrequency (RF) exposure warning: This equipment must be installed and operated in accordance with the provided instructions, and the antenna(s) used for this transmitter must be installed to provide a separation distance of at least 20 cm from all persons and must not be co-located or operated in conjunction with any other antenna or transmitter. End users and installers must be provided with antenna installation instructions and transmitter operating conditions for satisfying RF exposure compliance.
2. Federal Communications Commission (FCC) Interference Statement: This equipment has been tested and found to comply with the limits for a Class B digital device, pursuant to part 15 of the FCC Rules. These limits are designed to provide reasonable protection against harmful interference in a residential installation. This equipment generates, uses and can radiate radio frequency energy and, if not installed and used in accordance with the instructions, may cause harmful interference to radio communications. However, there is no guarantee that interference will not occur in a particular installation. If this equipment does cause harmful interference to radio or television reception, which can be determined by turning the equipment off and on, the user is encouraged to try to correct the interference by one or more of the following measures:
 1. Reorient or relocate the receiving antenna.
 2. Increase the separation between the equipment and receiver.
 3. Connect the equipment to an outlet on a circuit different from that to which the receiver is connected.
 4. Consult the dealer or an experienced radio/TV technician for help.

CAUTION: Any changes or modifications not expressly approved by the guarantee of this device could void the user's authority to operate the equipment.

Product Overview

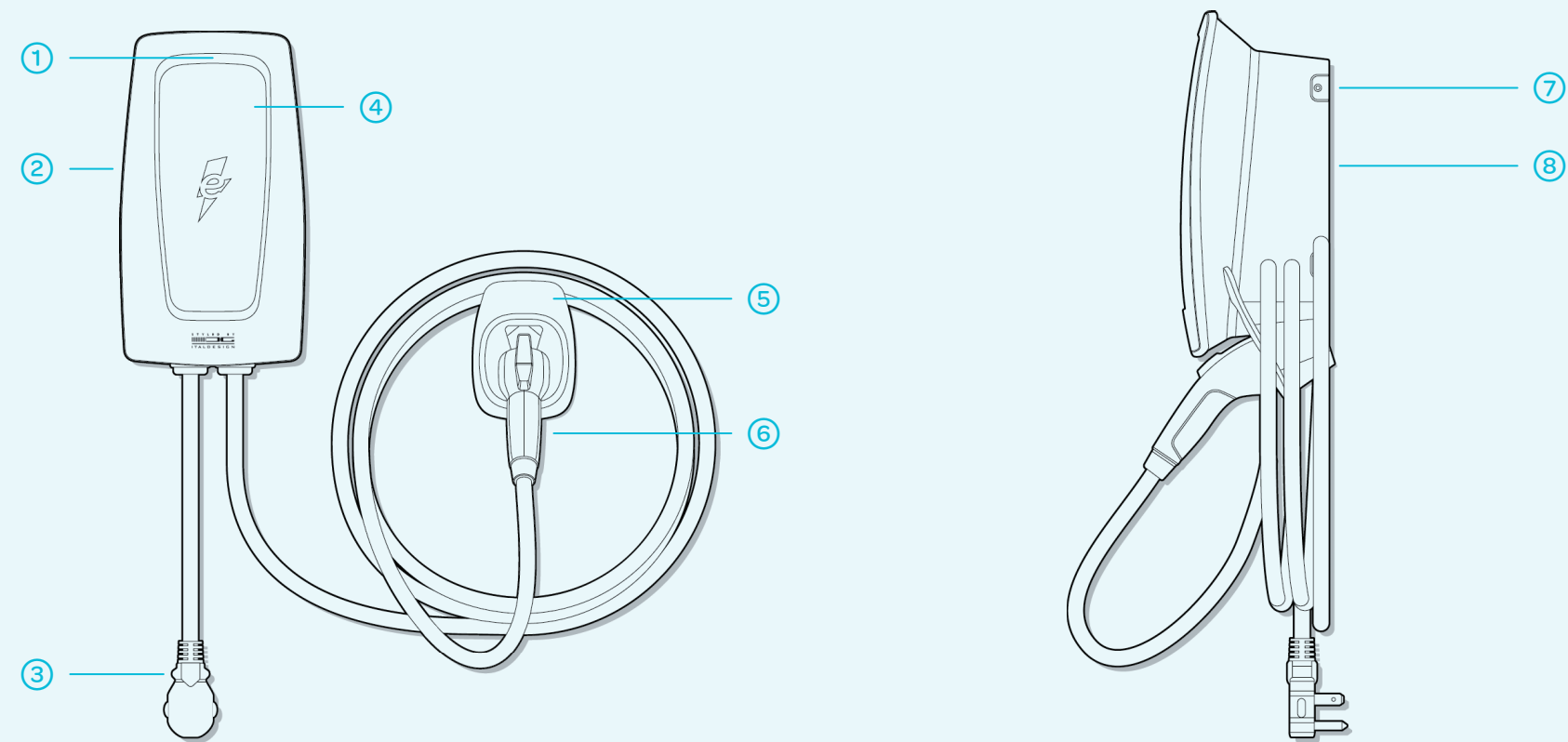

NO.	ITEM	NO.	ITEM
1	LED Ring	5	Cable Holster
2	Cosmetic Cover	6	Vehicle Connector
3	Plug	7	Mounting Bracket
4	Middle Cover	8	Body

1 Included Components List

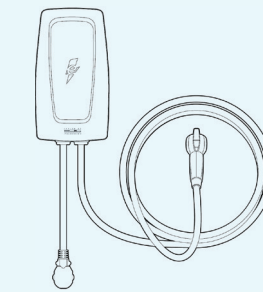

Charger

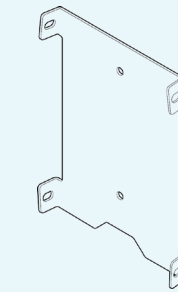

Mounting bracket x1

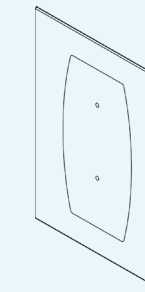

Mounting template x1



User manual x1



Holster case x1

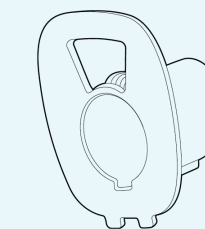

Holster inlet x1



No. 8 wood screws x 4
(2 for bracket, 2 for holster)



T20 Torx screw x 1
(for holster assembly)

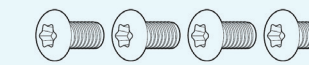

T30 Torx screws x 4
(for bracket assembly)



T20 Torx bit x1
T30 Torx bit x1

2 Recommended Tools

1 TOOLS FOR PLUG-IN INSTALLATION

1. Level
2. Pencil
3. Electric Drill
4. Phillips-Head Screwdriver

2 TOOLS FOR HARDWIRED INSTALLATION

1. Level
2. Pencil
3. Electric Drill
4. Phillips-Head Screwdriver
5. Diagonal Cutter
6. Needle-Nose Pliers
7. Wire Stripper
8. Ferrule Crimping Tool

Installation Instructions

1 Before Installing



We recommend that a certified electrician perform all in-home installations. Under no circumstances should the charger be installed without first consulting a certified and qualified electrician. Review these Installation Instructions and the directions in your Electrify America app carefully before installation. Failure to adhere to all instructions in this manual and the Electrify America app could result in damage to property, serious injury, or death.

Make sure to follow all local codes and regulations for safety and accessibility.

When considering installation locations, there are a few things to keep in mind:

1 DETERMINE YOUR POWER RATING

- Prior to installing your charger, work with your electrician to determine the amperage setting that best fits your home's electrical capacity. This may determine which type of installation you will need and the best location for the charger.

2 PICK YOUR LOCATION

- Install the mounting bracket for the charger—measured from the bottom of the bracket between 31.5" (80 cm) and 47.2" (120 cm) above the ground.

Configuration	Installation Type
16A	Hardwire Only
32A	Plug-In or Hardwire
40A	Plug-In or Hardwire

- Install the holster—measured from the bottom between 31.5" (80 cm) and 43.3" (110 cm) above the ground.
- To allow for proper airflow and working room, the charger should be placed at least 12" (30.5 cm) from any other equipment, walls, or other obstructions.
- The bracket must be mounted on a flat surface so that it does not deform when properly secured.
- Plug-In Installation Note: Prior to mounting the charger, turn off the circuit breaker for the desired outlet and plug in the charger. This will allow for proper placement of the charger.

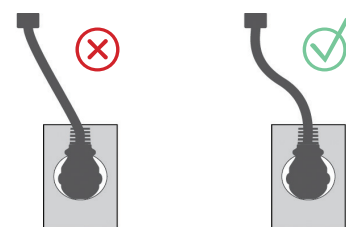

TIP: Be sure the power cord has a gentle curve but is not stretched.

- When selecting a location to install the charger, make sure that the charge cable can easily connect to the vehicle when it is parked. Keep in mind where the vehicle's charging port is located (it varies from vehicle to vehicle) and how the vehicle will usually be parked.
- The best installation locations have enough space to easily store the cable around the charger itself (or the holster provided with the charger), and will not interfere with pathways or other items in the garage or driveway.

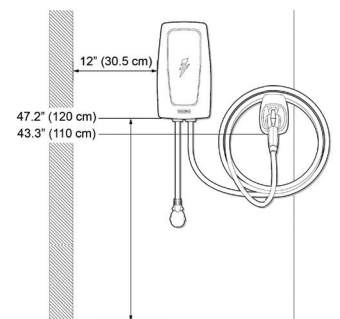

2 Installation Steps

This product must have a proper electrical ground connection. Proper electrical grounding reduces the risk of electric shock. This product is equipped with a power supply cable that includes an equipment grounding conductor. The power supply cable must be plugged into a compatible outlet that is properly installed and grounded in accordance with all local codes and ordinances.

WARNING: Improper connection of the power supply cable can result in electric shock. Check with a qualified electrician to ensure the product is properly grounded. Do not modify the power supply cable provided with the product. Ensure the proper outlet is installed by a licensed and qualified electrician.

1 INSTALL THE MOUNTING BRACKET AND CHARGER

- This product must be mounted on a wall. The mounting template, included with the product, shows the proper location to drill pilot holes for the mounting bracket screws.
- Using a level, place the mounting template in the location where you would like to mount the charger.
- Tape the template in place and measure the height to ensure the charger is between 31.5" (80 cm) and 47.2" (120 cm) above the ground.

NOTE: The bracket must be mounted on a flat surface so that the bracket does not deform when properly secured.

- Install the mounting bracket securely to the wall, aligning the holes in the bracket with those marked on the wall, and secure the mounting bracket using the provided screws or other fasteners that best suit your specific installation needs.

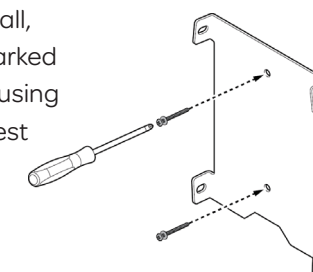

- Once the mounting bracket is installed, place the charger into the bracket and secure the charger to the bracket using the 4 supplied T30 Torx screws.

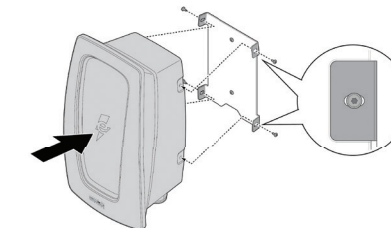

2 INSTALL THE HOLSTER

The cable holster is optional. Install the holster—measured from the bottom between 31.5" (80 cm) and 43.3" (110 cm) above the ground. Please select the proper mounting hardware for your particular installation.

3 PLUG-IN INSTALLATION USING THE ATTACHED SUPPLY POWER PLUG

Insert the power plug into the power outlet (NEMA 14-50 receptacle).

4 AMPERAGE CONFIGURATION WITH THE ELECTRIFY AMERICA APP

- Download and install the Electrify America app on your smartphone (available for iOS and Android).
- Ensure that your phone's Wi-Fi is turned on. Your phone does not need to be connected to a Wi-Fi network to connect your charger.
- Follow the instructions in the app to connect to your charger and configure your amperage setting.

3 Installation with Hardwiring



These installation instructions are intended for certified electricians. Only qualified, certified electricians should hardwire the charger. In addition to the charger installation instructions, follow all federal, state, and local laws, regulations, ordinances, codes, and safety standards.

This product must be properly grounded—either to a grounded, metal, permanent wiring system or an equipment-grounding conductor run with the supply power circuit conductors and connected to the grounding terminal on the product.

CAUTION: To reduce the risk of fire, connect only to a circuit provided with 50 amperes maximum branch circuit overcurrent protection (in accordance with the National Electrical Code, ANSI/NFPA 70).

1 REMOVE THE COSMETIC AND MIDDLE COVERS

1. Remove the screw located at the bottom of cosmetic cover by using the T20 Torx bit.
2. Tilt the cosmetic cover upward and separate it from the middle cover.
3. Remove the screws using the T20 Torx bit.
4. Place the middle cover on the body of the charger by hanging the two hooks on the back of the middle cover to the ledges at the bottom of the body.
5. Once the cover has been removed, open the cable management clip on the right-hand side of the enclosure to release the LED cable attached to the cover. This will allow the cover to be hung on the bottom of the charger.

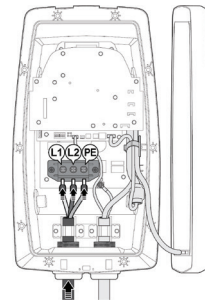

2 REMOVE THE PLUG CABLE

1. Remove the plug cable by loosening the 3 center screws (shown as L1, L2, and PE) in the terminal block. Do not loosen the screws securing the terminal block to the body.
2. This product has two means of strain relief: a metal bracket on the interior of the body and a black nut on the outside of the body.
3. Loosen the left strain relief nut on the outside of the body.
4. Remove the left strain relief strap from the inside of the body.
5. Pull the cable down through the cable gland and remove the strain relief nut from the plug cable.

3 FLIP THE COSMETIC COVER UPWARD TO SEPARATE IT FROM THE BODY

1. Insert the new cable through the cable gland nut, then into the body of the charger.

NOTE: The conductor size must be no less than 6 AWG.

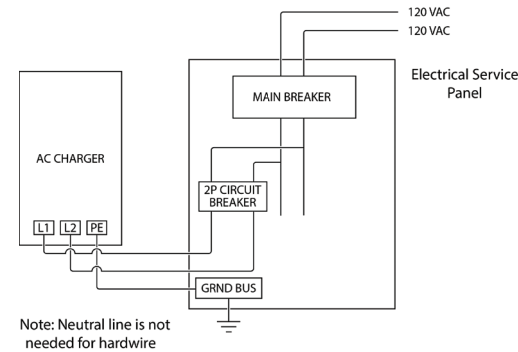

During installation, be sure to use proper personal protective equipment and do not touch wiring terminals with your fingers.

NOTE: The circuit breaker must be rated for 125% of the chosen operating current.

2. Crimp insulated wire ferrules onto each supply power wire, including ground. Follow the ferrule manufacturer's instructions for crimping the ferrules onto each wire.

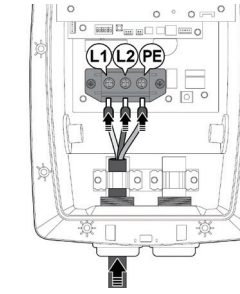

3. Insert each ferrule terminal wire in the terminal block, ensuring the wires are located properly.
4. Tighten terminal block screws to 33–40 in-lb (3.73–4.5 N-M) of torque.
5. Reinstall and tighten the strain relief strap, ensuring the wires are not strained between the strain relief strap and the terminal block.
6. Tighten the strain relief nut to the cable gland.

4 MANUAL AMPERAGE CONFIGURATION (OPTIONAL)

Use this method only if required by local code; otherwise, use the Electrify America app to set the amperage configuration.

1. The amperage of the charger can be manually set by configuring the DIP switches as shown at right. It is always preferable to configure the amperage via the Electrify America app.

NOTE: When there is a difference between the DIP switch settings and the setting in the Electrify America app, the charger will issue charge at the lowest amperage setting.

CONFIGURATION	MAX CURRENT RATINGS	CONFIGURATION	MAX CURRENT RATINGS
100	16A	001	40A (Default)
110	32A		

5 REATTACH THE COVER

1. Secure the middle cover with the screws removed in step 1.
2. Attach the cosmetic cover by placing the top edge of the cosmetic cover over the middle cover and gently pushing the cosmetic cover into place. Loosen the left strain relief nut on the outside of the body. Secure the cover with the T20 Torx screws.

6 AMPERAGE CONFIGURATION WITH THE ELECTRIFY AMERICA APP

1. Download and install the Electrify America app on your smartphone (available for iOS and Android).
2. Ensure that your phone's Wi-Fi is turned on. Your phone does not need to be connected to a Wi-Fi network to connect your charger.
3. Follow the instructions in the app to connect to your charger and configure your amperage setting.

7 WI-FI SETUP (PLUG-IN OR HARDWIRED INSTALLATION)

1. To connect the charger to a Wi-Fi network, download and install the Electrify America app on your smartphone (available for iOS and Android).
2. Follow the instructions in the app to set up with Wi-Fi connection.

NOTE: If the Wi-Fi signal is weak, inconsistent or unavailable at the installation location, we recommend installing a Wi-Fi repeater or range extender to improve the signal quality.

Operating Instructions

1

Insert the vehicle connector into the charging port on your electric vehicle. The charger will light up green when a connection is detected.

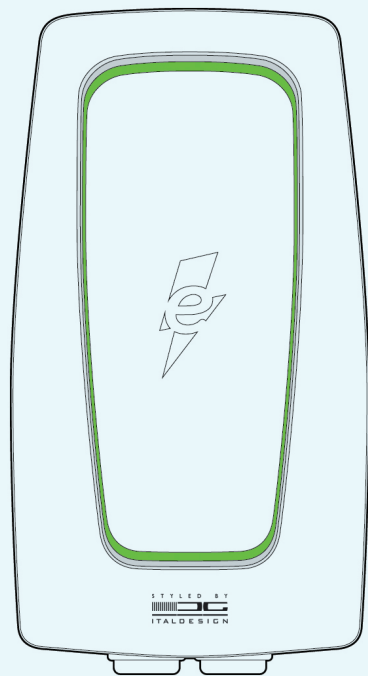

2

Once the charger is plugged into the vehicle, the charger will begin flashing blue as it links with the vehicle. When the charger is flashing solid blue, the vehicle is charging.

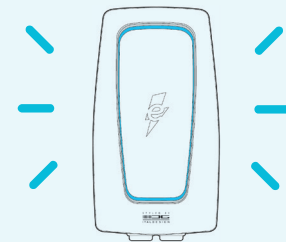

The charger light will dim on the front and remain blue on the bottom for the entire charging session.



3

Charging is complete when the charger turns green once more.



4

Press the thumb lever on the vehicle connector to disconnect from the vehicle.

NOTE: User experience may vary depending on the settings of the vehicle being charged. Please consult your vehicle's owners manual for more information.

Charger Status

If the unit is displaying a fault indicator light or if you are experiencing difficulty charging, please review the Troubleshooting section below.

If the issue persists, please contact Electrify America Customer Support at (833) 532-2778.

1 Status Indicator

The charger is equipped with an integrated LED ring to allow for clear communication of the charger's status. Only the bottom section of the LED ring will remain illuminated (for approximately two minutes) since the last user interaction.

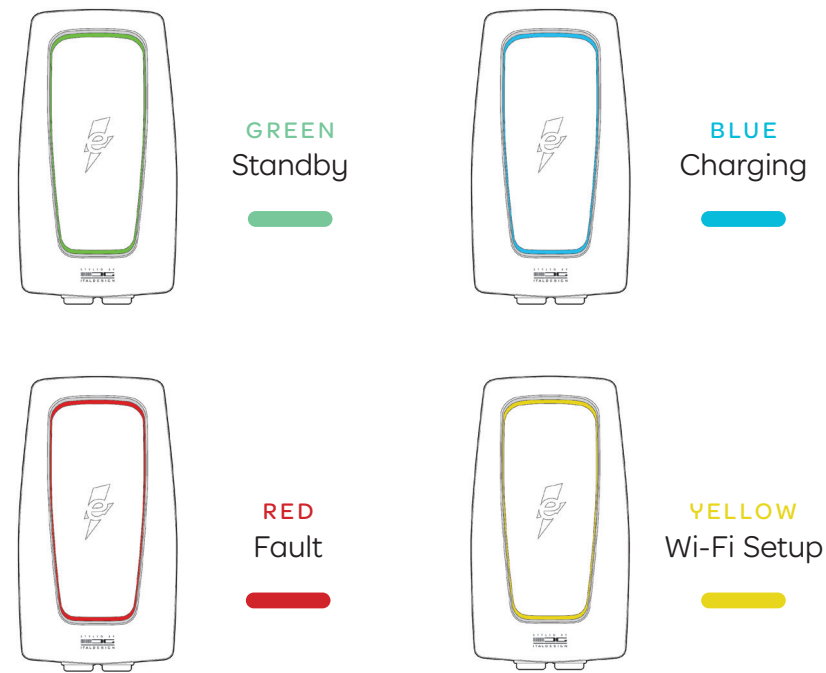

2 Indicator Definition

LED PATTERN	DEFINITION
Slow flashing	2 seconds between flashes.
Fast flashing	Less than 1 second between flashes.
1 flash	1 second on, 5 seconds off.
2 flashes	1 second on, 1 second off; 1 second on, 5 seconds off.
3+ flashes	Follows the same flashing pattern as directly above.

3 Understanding Status Indicator Patterns

LED COLOR INDICATOR	DESCRIPTION
No color 	Power off.
Blue & green, alternating and fast flashing 	Initial and self-test.
Green, solid 	Standby.
Blue, fast flashing 	EV connected.
Blue, slow flashing 	Preparing to charge.
Blue, solid 	Charging.
Green, slow flashing 	Charging finished or stopped by user.
Yellow, solid 	First successful connection to Wi-Fi.
Red, constant and/or flashing 	Fault indicator. See the Troubleshooting section.

4 Faults

LED INDICATOR	DESCRIPTION
Red, 1 flash 	High or low input voltage detected.
Red, 2 flashes 	Ground fault detected.
Red, 3 flashes 	Ground connection error.
Red, 4 flashes 	High input current detected.
Red, 5 flashes 	Operating temperature limit exceeded. Disconnect the unit from power.
Red, 6 flashes 	Installation error. Line and neutral are swapped.
Red, 7 flashes 	Vehicle communication error.
Red, solid 	Self-test error or general error. Disconnect the charger from power source and reconnect it after 10 seconds to power cycle the charger.

Troubleshooting

ISSUE	CAUSE	ACTION
Status indicator does not illuminate.	Charger is not receiving power.	<p>Ask a certified electrician to check that the power input is connected correctly and the power is within operating range of the unit.</p> <p>Disconnect the charger from power source and reconnect after 10 seconds to power cycle the charger.</p> <p>If the problem persists, contact Customer Support at (833) 532-2778.</p>
Indicator does not flash blue after plugging in the vehicle connector.	Vehicle battery is fully charged. Plug is not properly connected.	<p>Check if the EV battery is fully charged.</p> <p>Check if the vehicle connector is fully inserted to the EV.</p> <p>If the problem persists, contact Customer Support at (833) 532-2778.</p>
Indicator starts to flash red while charging.	Charger has detected an error. Charger has encountered a fault.	<p>Wait until the temporary error is resolved and the charger returns to normal condition, typically less than 10 seconds.</p> <p>Disconnect the charger from the vehicle, wait for the error to clear, and reconnect the charger to the vehicle.</p> <p>If the error persists, disconnect the charger from power source and reconnect after 10 seconds to power cycle the charger.</p> <p>If the error is not resolved, contact Customer Support at (833) 532-2778.</p>
Indicator illuminates red.	Charger has detected a fault.	<p>Disconnect the charger from the vehicle, wait for the error to clear, and reconnect the charger to the vehicle.</p> <p>If the error persists, disconnect the charger from power source and reconnect after 10 seconds to power cycle the charger.</p> <p>If the error is not resolved, contact Customer Support at (833) 532-2778.</p>

Specifications

Model	EA2R040JPA10-00
Measurements (H x W x D)	15.75" x 8.66" x 6.75" (approx.)
Cable Length	24 Feet
Installation Type	Fixed Wall Mounted
Weight	19.85 lbs. (approx.)
Enclosure Rating	NEMA Type 3R
Input Power	208V-240V AC Split Phase (3-Wire – L1, L2, Ground)
AC Plug-In Cord	NEMA 14-50
Max. Current Rating	40 Amps, configurable to 32A or 16A
Output Power	Up to 9.6kW (240V AC @ 40A)
Power Metering	Accuracy +/- 1% at Full Scale
Charge Connector	SAE J1772
Charging Protocol	SAE J1772
User Interface/HMI	LED Light Ring
Wireless	WLAN with 2.4GHz b/g/n with WPA2

Communication Protocol	OCPP 1.6+ JSON Compliant
AC Fault Monitor	GFCI Integrated (20mA CCID for AC)
Short Circuit/Overload Protection	50A Circuit Breaker (not provided with unit, no GFCI) for 40A Output (Refer to local codes for proper breaker sizing.)
Vehicle Communication	Pilot Signal (IEC 61851-1:2017)
Certifications	UL2594, UL2231-1&2, FCC Part 15, Class B
Operating Temperature	-22°F to +122°F (-30°C to +50°C) Full Load Thermal Overload Protection: Output power reduced at higher temperatures.
Storage Temperature	-40°F to +176°F (-40°C to +80°C)
Humidity	5%–95% (Non-Condensing)

Moving, Transportation, and Storage

WARNING: Improper moving or storage of this device may result in fire or electric shock.

Do not lift or carry the charger by the cords. Do not allow the connector cable to drag or touch the ground when moving the charger. This device should be stored in a dry location that's between -40°F and +176°F.

Cleaning

The charger may only be cleaned with water; the use of lukewarm water is recommended. Do not use cleaning agents containing solvents. Dry the charger with a clean paper towel or soft cloth prior to use.

Do not use this product if the power cord or the electric vehicle cable is frayed, has broken insulation, or shows any other signs of damage. Do not use this product if the enclosure or the electric vehicle connector is broken, cracked, open, or shows any other indication of damage.

For further assistance, contact us at (833) 532-2778.

Warranty

Customer Support can provide more information on the terms of the warranty. However, the following cases are not covered by the warranty:

- A. Defects or damage caused by any failure to install, operate, or care for this product as specified in this Installation and Operation Manual and the Electrify America app.
- B. Costs and damage caused by repair work which has not been made by an Electrify America-approved authorized specialist or electrician.

Disposal

The charger is an electrical device. Follow all federal, state, and local laws, regulations, ordinances, and safety standards regarding disposal of this device.



ELECTRIFYHOME.COM

Customer Support: (833) 532-2778



Version: 1.0.7

Issue Date: August 31, 2021

